

USER MANUAL PLATINUM Brushless Electronic Speed Controller PLATINUM 150A V5.1

20240523

HW-SMA00BDUL

01 Disclaimer



Thank you for purchasing this HOBBYWING product! Please read this declaration carefully before use, once you start to use, we will assume that you have read and agreed with all the content. Brushless power systems can be very dangerous and any improper use may cause personal injury and damage to the product and related devices, so please strictly follow the instruction during installation and use. Since we have no control over the use, installation, or maintenance of this product, no liability may be assumed for any damages or losses resulting from the use of this product. We do not assume responsibility for any losses caused by unauthorized modifications to our product. We have the right to modify our product design, appearance, features and usage requirements without notification. We, HOBBYWING, are only responsible for our product cost and nothing else as result of using our product. Regarding the possible semantic difference between two different versions of declaration, for users in mainland China, please take the Chinese version as standard; for users in other regions, please take the English version as standard.

06 Programmable parameter items and instructions

1 Programmable parameter items and parameter values

Item	Value
1 Flight mode	Fixed-wing Helicopter External Governor *Helicopter Elf Governor Helicopter Store Governor
2 LiPo cells	*Auto Calculation 3S 4S 5S 6S 7S 8S
3 Low-Voltage Cutoff Type	*Soft Cutoff Hard Cutoff
4 Cutoff Voltage	Disabled 2.8V-3.8V (Default *3.0V)
5 BEC Voltage	5-12V (Default *6.0V)
6 Response time	4-25 (Default *15)
7 Governor parameter P	0-9 (Default *4)
8 Governor parameter I	0-9 (Default *5)
9 Auto Restart Time	0-90 seconds (Default *25 seconds)
10 Restart acceleration time	1-3 seconds (Default *1.5 seconds)
11 Brake Type	* Disabled Normal brake Reverse brake
12 Brake Force	0-100% (Default 0%)
13 Timing	0°-30° (Default 25°)
14 Motor direction	*CW CCW
15 Active Freeheeling	*Enabled Disabled
16 Start-up force	1-7 (Default *3)

** in the form below indicate factory defaults.

2 Programmable parameters project description

- Flight mode:**
 - Fixed-wing mode:** Suitable for fixed-wing. In this mode, the throttle has to be more than 5% to start the motor and the throttle response is linear.
 - Helicopter external Governor mode:** Suitable for helicopter aircraft without any fixed speed equipment or helicopter aircraft using external speed control equipment. The throttle has to be higher than 5% (including 5%) before starting the motor. After the slow start is completed, the motor will start off in a smoother manner, followed by a faster throttle response accelerated to the current throttle value.
 - Helicopter Elf Governor Mode:** Suitable for helicopter aircraft flying at fixed speed. The throttle has to be higher than 40% (including 40%) before starting the motor. In the slow start process, the motor starts off in an ultra-smooth acceleration to complete the speed calibration.
 - Helicopter store Governor mode:** Suitable for the use of fixed speed flight helicopter aircraft. The throttle in this mode has to be more than 40% (including 40%) before starting the motor. The motor starts in an ultra-smooth manner, after the completion of slow start speed into the fixed speed operating state.
- *Note that speed calibration must be done each time other modes are switched to using this mode.**
- LiPo cells:** The number of battery cells can be calculated automatically and set manually. Select Auto-calculation to calculate the number of battery cells. Error on battery cells will be detectable during self-test and can be adjusted accordingly.
- Low-Voltage Cutoff Type:**
 - Soft Cutoff:** The output power will be gradually reduced to 50% of the total power output after low voltage protection is triggered.
 - Hard Cutoff:** Disconnect the power output immediately after low-current protection is triggered.
- Cutoff Voltage:** 2.8V-3.8V with 0.1V step adjustability. When using 6S batteries, the protection voltage should be Cutoff Voltage × battery cell count.
- BEC Voltage:** The ESC is built-in with a BEC of 5-12V and has the capability to adjust 0.1v per step.
- Response time:** Adjust the response speed of the throttle in "helicopter elf Governor" or "store Governor". The higher the value, the slower the throttle response speed. 4-25 fully adjustable.
- Governor parameter P:** This item is for controlling the ESC compensate the amount of the motor speed during the process of maintaining the speed-governing effect; the higher the value, the bigger the amount; and vice versa. This function functions together with the Governor Parameter I.
- Governor parameter I:** When the speed falls below, or exceeds the value set, the speed is compensated by the ESC. This parameter is used to resize the degree of rotation. Too large parameters will cause excessive make-up, too small parameters will cause insufficient replacement.
- Auto Restart Time:** This feature is only available in helicopter elf or storage fixed speed modes. It is the time set to push the throttle from more than 40% to 25% to 40% throttle range, and then push back more than 40%. The parameter will not take effect when the throttle range is below 25% or between 25%-40% beyond the set time. The ESC will execute the "helicopter elf / storage fixed speed" modes of the default start-up process only if the throttle range is above 40%.
- Restart acceleration time:** 1-3 seconds, with 0.5 seconds step adjustability. This parameter controls the time required for the motor to accelerate from zero to full speed during a quick restart. (This is an auxiliary function and is only valid if the "time to turn off and land" function is valid)
- Brake types:**
 - Normal brake:** This function will stop the motor from braking during operating according to the value set on the braking force.
 - Reverse Brake:** After selected this option, the Yellow signal wire (its signal range must be the same as the throttle range) must to be plugged into any vacant channel on the receiver, and you can control the motor direction via that channel. The channel range of 0-50% is the default motor direction, and the channel range of 50% to 100% will cause the motor to spin in the reverse direction. The channel stick should be within the channel range of 0-50% (0 would be better) when the first time you power on the ESC. After the Reverse function is activated, the motor will stop first and then spin in the reversed direction and then increase to the speed corresponding to the throttle input. Any signal loss, including the reverse break signal will cause the signal loss protection to be activated.
- Brake Force:** The greater the value, the shorter the time taken for the motor to come to a standstill. 0-100%, with 1% step adjustability. This function is only valid in normal brake mode.
- Timing:** This item is for adjusting the ESC timing, it's adjustable between 0 and 30° with the step of 1°.
- Motor direction:** This item is for setting the rotation direction of the motor, it's "CW" by default. After connecting the motor to the ESC, (if the motor rotates clockwise), when setting this item to "CCW", the motor will rotate counterclockwise; (if the motor rotates counterclockwise), when setting this item to "CW", the motor will rotate clockwise.
- Active Freeheeling:** This item can be enabled or disabled when the "Flight Mode" is set to the "Fixed-wing" or "Helicopter (External Governor) mode"; it's fixed at "Enabled" when the "Flight Mode" is set to the "Helicopter (Elf Governor)" or "Helicopter (Store Governor)" mode. With this item enabled, the throttle response will be improved.
- Start-up force:** This item is for adjusting the start-up force of the motor (during the start-up process). The higher the value, the larger the start-up force. It's adjustable between 1 and 7.

02 Warnings

- Before using this product, read the instruction manual carefully. Ensure that all components are used correctly to avoid any damage of the ESC and other components of the system.
- It is important to ensure that all wires soldered are properly secured to avoid short circuits from happening. A good soldering station is recommended to do such a job to avoid overheating the circuit board as well as to ensure connections are properly soldered.
- Even though the product has relevant protective measures, always use it in a safe manner in accordance with the operating environment noted in the manual (e.g. voltage, current, temperature and etc).
- Always remember to disconnect the battery each time after using it. Failure to do so will cause the battery to be completely discharged, resulting in an unpredictable danger.

03 specifications

Model	PLATINUM 150A V5.1
Continuous/Peak current	150A/180A
Input voltage	3-8S LiPo battery
BEC	Switch Mode BEC, output voltage 5-12V adjustable (adjusted 1V); output current Cont. 10A, Peak 30A
Input/Output wires	1 x black and 1 x red 10AWG silicone wires / 3 x black 12AWG silicone wires
Independent parameter programming interface	Connect LCD program box or OTA module, or to power the cooling fan
LED light	Display the statuses and fault alerts
Size/Weight	83.2*37.1*22.5mm / 150.4g (with wires, No fan)
The scope of application	520-580 class electric helicopter (Main blade length 520-580mm) or fixed-wing

04 User Guide

1 Wiring diagram

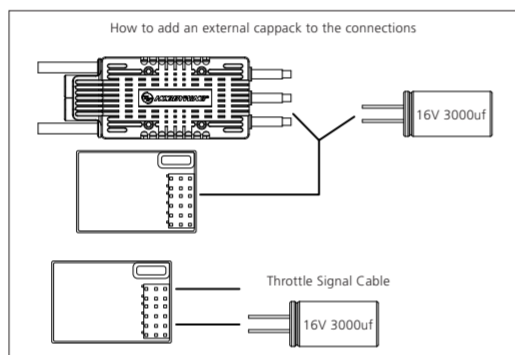
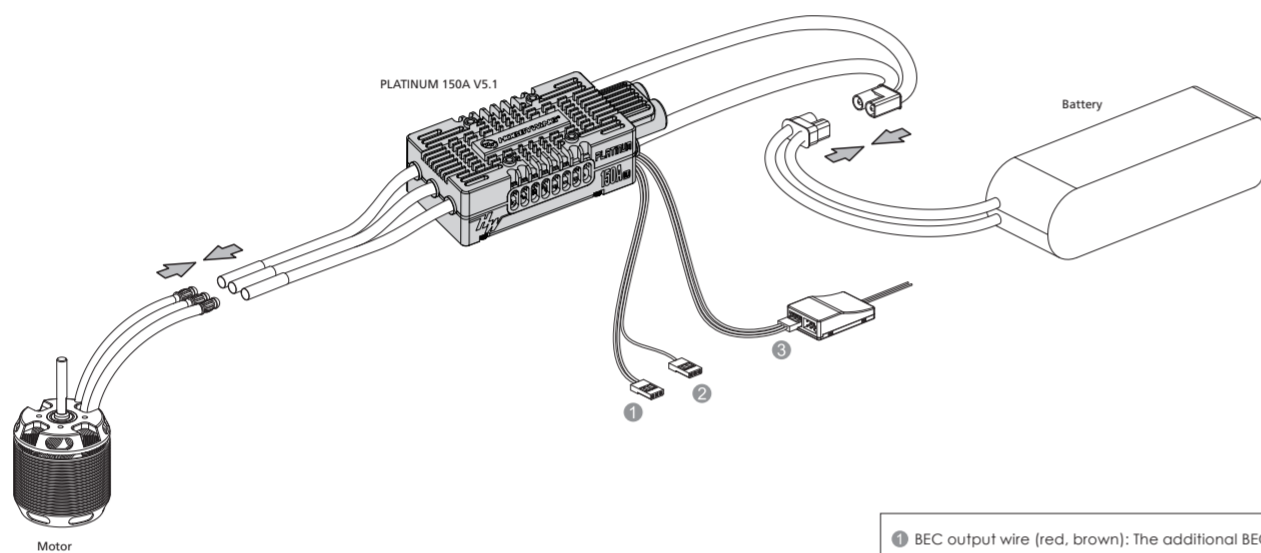

- BEC output wire (red, brown): The additional BEC output wire is plugged into the receiver battery dedicated channel or any available channel. (For better BEC power output, it is recommended to insert the BEC cable into a battery-specific channel or any available channel).
- RPM signal wire (yellow): electrical RPM output line of the motor needs to be connected to the RPM in of an external device (such as a Flybarless system gyro).
- Throttle signal wire (white, red, black): Insert into the receiver throttle channel. Depending on the receiver type, the white wire is to transmit the throttle signal, whereas the red and black lines are parallel to the output of the internal BEC (e.g. the BEC voltage output wire and ground wire).

2 External Capacitor Module (also called Cappa)k Wiring (Optional)

For this ESC, its BEC load capacity may be insufficient when using high power servos. In that case, we suggest connecting the stock external cappa to the BEC's output end (i.e. any idle channel on the receiver *note 1) in parallel. Users can check if the BEC is working in overload condition by the following method: keep moving relevant throttle sticks (that control servos) to start/stop those servos and change directions quickly to see if the receiver or flight control system (if exists) will be restarted during the process. If restart occurs, then it means that the sudden load of the electronic system exceeds the BEC's output capacity and an external cappa is needed.

Note 1: If there is no vacant channel on the receiver, then users can connect a short, larger gauge wire, (smaller gauge and longer wires may affect the capacitor's performance, and is not recommended) to the BEC's output wires in parallel.

3 Normal boot process



4 Throttle stick calibration operation method

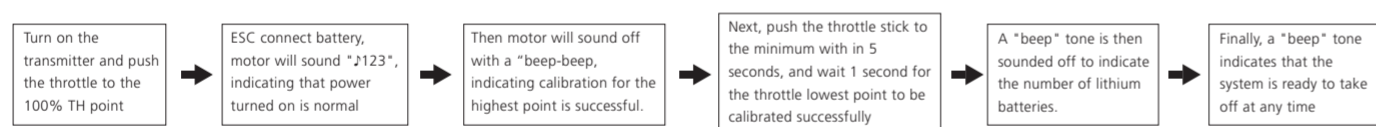

- ESC default throttle range is 1100µs-1940µs (Futaba standard). The throttle range should always be re-calibrated for the first time or when transmitter have been replaced.
- Before calibration, always have the throttle curve set to default. Ensure that the throttle value corresponds to the highest point(100%) of the remote control throttle and the lowest throttle point (0%).

05 Esc programming and Data checking

- The ESC parameters can be programmed specifically to meet different flight needs.
- The ESC will be able to record the calibration speed of the current flight (only in storage fixed speed mode), the minimal voltage, maximum temperature and other information. Please do not disconnect the power from the battery as the information will not be saved after the power has been disconnected. Connect LCD program box or OTA module to view.

1 Use Multifunction LCD program box to program ESC parameters (need to purchase separately)

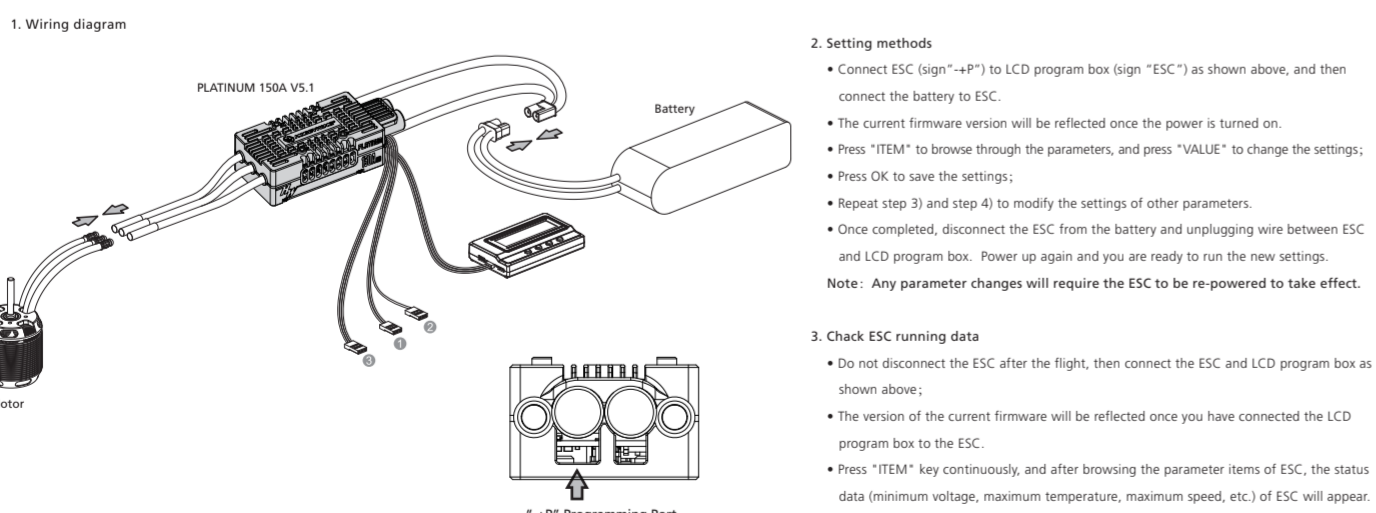

- Setting methods**
 - Connect ESC (sign "+"P) to LCD program box (sign "ESC") as shown above, and then connect the battery to ESC.
 - The current firmware version will be reflected once the power is turned on.
 - Press "ITEM" to browse through the parameters, and press "VALUE" to change the settings;
 - Press OK to save the settings;
 - Repeat step 3) and step 4) to modify the settings of other parameters.
 - Once completed, disconnect the ESC from the battery and unplugging wire between ESC and LCD program box. Power up again and you are ready to run the new settings.
- Check ESC running data**
 - Do not disconnect the ESC after the flight, then connect the ESC and LCD program box as shown above;
 - The version of the current firmware will be reflected once you have connected the LCD program box to the ESC.
 - Press "ITEM" key continuously, and after browsing the parameter items of ESC, the status data (minimum voltage, maximum temperature, maximum speed, etc.) of ESC will appear.

2 Use OTA Module to program ESC parameters (sold separately)

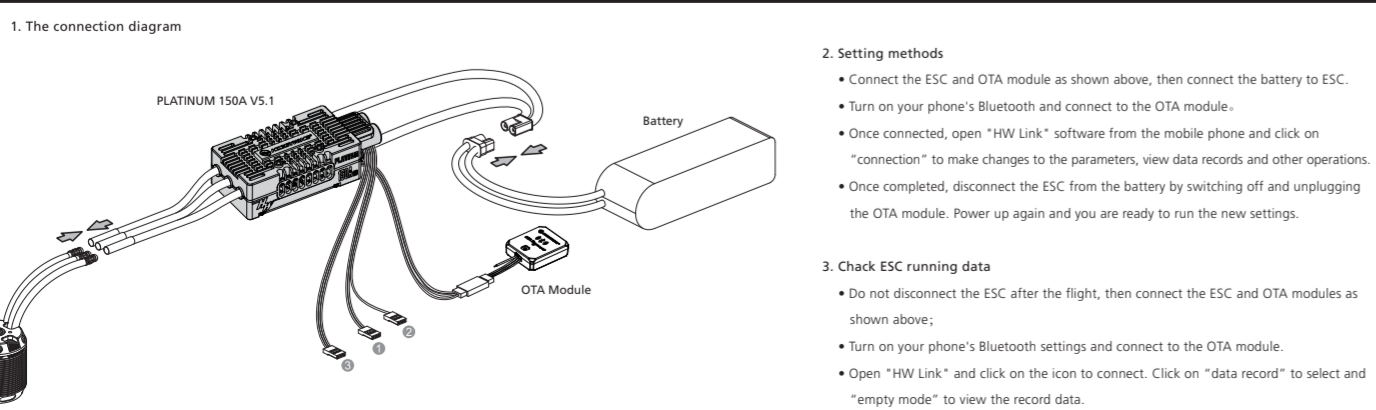

- Setting methods**
 - Connect the ESC and OTA module as shown above, then connect the battery to ESC.
 - Turn on your phone's Bluetooth and connect to the OTA module.
 - Once connected, open "HW Link" software from the mobile phone and click on "connection" to make changes to the parameters, view data records and other operations.
 - Once completed, disconnect the ESC from the battery by switching off and unplugging the OTA module. Power up again and you are ready to run the new settings.
- Check ESC running data**
 - Do not disconnect the ESC after the flight, then connect the ESC and OTA modules as shown above;
 - Turn on your phone's Bluetooth settings and connect to the OTA module.
 - Open "HW Link" and click on the icon to connect. Click on "data record" to select and "empty mode" to view the record data.

07 Speed Governor Function

1 Explanation for ESC Speed-governing

Establish the "Motor RPM-Throttle Amount Curve" via the speed standardization, and then set the throttle amount to some fixed value on the transmitter, in that condition, the motor will output the RPM corresponds to the throttle amount and keep rotating at that speed.

- In the "Helicopter (Elf Governor)" mode, the ESC won't save the "Motor RPM-Throttle" curve after it's disconnected from the battery, so every time the ESC is connected to the battery, it will standardize the speed, otherwise you cannot use the speed-governing function normally. In this mode, due to the differences like batteries' different discharge capacity, the standardized RPM is a little different every time. In consequence, at the same throttle amount, the RPM may be a bit different when using different batteries, but this won't affect the speed-governing effect.
- In the "Helicopter (Store Governor)" mode, the ESC will save the "Motor RPM-Throttle" curve after the speed standardization. So after adjusting this mode from any other mode, you need to standardize the speed when the ESC is connected to the battery for the first time and you need to standardize the speed again after disconnecting the ESC from the battery first and then connecting it to the battery again. If adjusting to any other mode from this mode and saving the "Motor RPM-Throttle" curve, and then adjusting back to this mode, the "Motor RPM-Throttle" curve saved by the ESC will be cleared, and you need to standardize the speed once again. If your ESC remains in this mode in future, then it will always carry out its operation as per the saved "Motor RPM-Throttle" curve. When standardize the speed for the first time, we recommend using a battery in good condition. After the RPM standardization, change another battery with the same number of cells to fly your aircraft. At the same throttle amount, the RPM should be consistent with the RPM of the first flight.

2 RPM Standardization

- Theory of RPM Standardization**

During the RPM standardization, the ESC will establish a "Motor RPM-Throttle" curve by itself based on the actual battery voltage and the actual KV rating of the motor. Therefore, you need to standardize the speed with a fully charged battery, and ensure the main blade pitch is 0° (in order to make the helicopter not take off). In general, people use the default "Throttle Curve & Pitch Curve" of the transmitter (as shown below) when they standardize the speed.

Attention! Please ensure the main blade pitch is 0° and the throttle amount is above 40% (we recommend using 50% when standardizing the speed).
- Procedures of RPM Standardization**
 - We recommend using the default "Throttle Curve & Pitch Curve". (If you don't want to use the default setting, then please ensure the throttlePitch Curve amount is 50% and the main blade pitch is 0° when the motor rotates)
 - Turn on the transmitter, move the throttle stick to the bottom position and then wait for the ESC completing the self detection.
 - If you've set the "throttle cut" function, please lock the "throttle cut", and then move the throttle stick to the 50% position and then unlock the "throttle cut". If there is no "throttle cut", then you can move the throttle stick to the 50% position directly.
 - The ESC drives the motor to rotate, the main blades start to accelerate slowly because the main blade pitch is 0°, so the helicopter won't take off, but you still needs to be careful, you need to wait for the acceleration completing and the speed getting stable, and then lock the "throttle cut" or move the throttle stick to the bottom position.
 - The ESC will stop driving the motor, the main blades start to slow down and then stop rotating.
 - The RPM standardization completes.

Attention! Please calibrate the throttle range before the RPM standardization. There will be no need if you've carried out the ESC/Radio Calibration when the first time you used this ESC or you didn't restore the settings to factory defaults after the calibration (changing the transmitter & receiver is an exception).

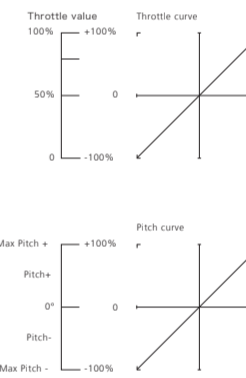

3 How to Set the Speed-governing Function

- The best throttle amount (set in the Helicopter "Store Governor" mode) of the ESC ranges from 70% to 90%, so please try to set the throttle amount (set in the Helicopter "Store Governor" mode) within this range. A low throttle amount (set in the Helicopter "Store Governor" mode) will make the ESC always function inefficiently, while a high throttle amount (set in the Helicopter "Store Governor" mode) will leave the ESC a very small compensation space, then compensation insufficiency issue may happen and cause (speed decrease) problem when the load is high. In that case, we recommend changing the motor or drive gear ratio (you need to re-standardize the speed after you change the motor or drive gear ratio).
- In the "Helicopter (Store Governor)" mode, if fly your aircraft with a low performance battery after standardizing the speed with a high performance battery may cause damage to the low performance battery.
- In "Helicopter (Store Governor)" mode, different battery packs can bring the same stable RPM only if they have the same cell count. This won't change even when you change the battery pack. However, battery packs with different cell count don't have the same effect. For instance, in "Helicopter (Store Governor)" mode, you can use a 4S to calibrate the motor RPM and then use a 6S to drive the motor, hoping it can run at the same RPM.
- You can decide the control feel via adjusting Governor Parameter P. In "Helicopter (Store Governor) or Helicopter (Elf Governor)" mode, connect your ESC to a smart phone or PC, then you can check the "throttle vs speed" chart.

- In "Helicopter (Store Governor)" mode, you can check the standardized speed (Max. RPM) and needn't standardize the speed every time when the ESC is connected to the battery as in the "Helicopter (Elf Governor)" mode, so it's more convenient. We recommend using this mode in the condition that you're using fixed motor, drive gear ratio and battery (with same cell count). In this mode, only if the drive gear ratio is accurate, the main blades' RPM corresponds to the throttle amount (set in the Helicopter "Store Governor" mode) you will get it will be accurate as well. About how to "set the speed-governing function" in this mode, let's take an example.
 - In "Helicopter (Store Governor)" mode, connect the ESC to the LCD program box or WiFi Express module when the RPM standardization completes, and then find the record (as shown below) as per the instruction about the "data checking" process.
 - The value shown in the image is just an example, please take the value actually displayed on your LCD program box as standard. This value is the max. electrical RPM the motor can reach at the 100% throttle.
 - Take a helicopter with single reduction gear unit as an example, with the motor poles is 10, the motor drive gear is 13T and the main drive gear is 120T (that the drive gear ratio is 9.3), then you can get the main blades' RPM at the 100% throttle.

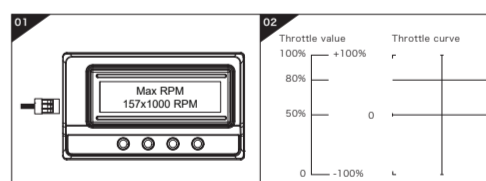

Formula: Main Blades' RPM (at the 100% throttle) = Max. RPM × (Motor Poles ÷ 2) ÷ Drive Gear Ratio
 Main Blades' RPM (at the 100% throttle) in the example is: 157 × 1000 ÷ (10 ÷ 2) ÷ (120 ÷ 13) = 3400 RPM
 If the Main Blades' RPM needs to remain at 2700RPM during the 3D flight process, then you need to set the throttle amount (set in the Helicopter "Store Governor" mode) to 2700 ÷ 3400 = 0.8, that is you need to set the throttle amount to 80%. At this time, you need to set the value of the 3D throttle curve (i.e. IDE1) to 80% (as shown below) so next time, when you fly your helicopter, let it take off in the "Normal" mode first and then switch to the "IDE1" mode directly, then your helicopter can start the 3D flight with 80% throttle amount (that's the standardized speed of 2700 RPM).
 Notes: In general, you can set and save 2/3 sets of throttle curve IDE settings on a high quality transmitter (and you need to adjust the main blade pitch of each set of IDE setting as per the actual demand), and switch between these settings during the flight and have the different throttle amount (set in the Helicopter "Store Governor" mode) to meet the different RPM demands (i.e. when setting IDE1 to 70%, IDE2 to 80%, IDE3 to 90% in the way as explained earlier, then you will have three different throttle amounts (set in the Helicopter "Store Governor" mode) to meet different flight demands.
 2. In the "Helicopter (Elf Governor)" mode, you are not allowed to check the Max. RPM, so you need to set the transmitter in advance and check the main blades' RPM with the help of some external device (like RPM viewer) and then decide the throttle amount you need to set. Here you can calculate the throttle amount roughly. For example, if the KV rating of the motor is 480KV, the battery is a 12S LiPo, the motor drive gear is 13T and the main drive gear is 110T, then the main blades' RPM is: KV Rating × Battery Voltage ÷ Drive Gear Ratio (480 × 12 × 4.2 ÷ 13 × 110 = 2850). So if you want your motor to rotate at the speed of 2150RPM, then the throttle amount is: 2150 ÷ 2850 = 0.75 (that is 75%), and then you adjust it accordingly as per your preference or the data you read on the RPM viewer.

08 Warning Tones and Protection

1 LED indicators and warning notes

Protection	Tone	LED indicator	Instruction
The input voltage is abnormal	"BB, BB, BB, BB, ..."	Red LED, followed by the tone	The input voltage is not within the input voltage range
Throttle signal loss	"B, ..., B, ..., B, ..., ..."	Red LED, followed by the tone	The throttle signal input was not detected
The throttle stick is not moved to the 0% position.	"B, B, B, B, ..."	Red LED, followed by the tone	The throttle value is not at 0% throttle
The throttle range is too small	"B, B, B, B, ..."	Red LED, followed by the tone	When calibrating the throttle stroke, set the throttle travel too small
Temperature protection	"BB, BB, ..." or "BBB, BBB, ..."	Red LED, followed by the tone	The internal temperature of the ESC exceeds the protection temperature
Low voltage protection	"BBBB, BBBB, ..."	Red LED, followed by the tone	The operating voltage is lower than the set protection voltage
Current protection	None	Red is always bright	The operating current is higher than the set current

2 Protection function description

- Abnormal power-on voltage protection:** The ESC enters a protective state once the input voltage detected is not in the operating range. Prompting LED light to flash.
- Start-up protection:** The start-up protection will be able to detect the motor speed from when the speed rises or the rising speed is unstable. If the throttle input is less than 15%, the ESC will try to restart automatically. (This may occur due to: Poor contact between the ESC and motor connections, individual output wires, faulty motor, propellers blocked by other objects, Binding gears, etc.)
- Temperature protection:** When the operating temperature of the ESC has exceeded 120 degrees Celsius, power will be gradually reduced for safety, but will not be turned off. There will still be up to 50% of power, to ensure that the motor has the power to land. After the temperature drops, the ESC will gradually be restored back to maximum power. ESC temperature must not exceed 70 degrees or it will not work. Prompting LED light to flash (above is the soft-off protection mode, if you choose hard-off, cut off the power directly)
- Throttle signal loss protection:** When the throttle signal is lost for more than 0.25 seconds, the output is immediately switched off to avoid further damage due to the propeller rotating at a high speed. Once the signal has been restored, the power output will be restored.
- Overloading protection:** When there is a sudden surge of current, power will be cut off and will be restarted. If the load is still abnormal after the restart, the power will be completely cut off.
- Low voltage cutoff protection:** When the operating voltage of the ESC has exceeded the protection voltage set, power will be gradually reduced for safety, but will not be turned off. There will still be up to 50% of power, to ensure that the motor has the power to land.
- Over-current protection:** The current will be cut off immediately once the set value has been breached.