

USER MANUAL PLATINUM

Brushless Electronic Speed Controller
HV 130A V4 • HV 130A OPTO V4

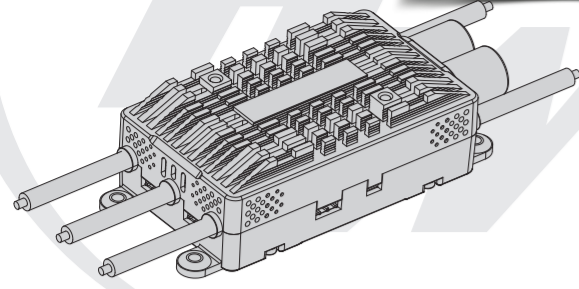

201903002



Thank you for purchasing this HOBBYWING product. Please read this declaration carefully before use, once you start to use, we will assume that you have read and agreed with all the content. Brushless power systems can be very dangerous and any improper use may cause personal injury and damage to the product and related devices, so please strictly follow the instruction during installation and use. Because we have no control over the use, installation, or maintenance of this product, no liability will be assumed for any damage or losses resulting from the use of the product. We do not assume responsibility for any losses caused by unauthorized modifications to our product. Besides, we have the right to modify our product design, appearance, features and usage requirements without notification. We, HOBBYWING, are only responsible for our product cost and nothing else as result of using our product. Regarding the possible semantic difference between two different versions of declaration, for users in mainland China, please take the Chinese version as standard; for users in other regions, please take the English version as standard.

01 Warnings

- Read through the manuals of all power devices and air craft and ensure the power configuration is rational before using this unit, as improper power configuration will overload the motor and damage the unit.
- When installing this unit, relevant operations like soldering, connecting will be needed, so please ensure all wires and connections are well insulated before connecting the unit to related devices, as short circuit will damage the unit. When soldering relevant wires of the unit, please use a soldering iron with sufficient power to do the soldering, as poor connection may cause your aircraft to lose control or other unpredictable issues like damage to the device.
- Always keep your air craft away from unsafe elements like obstacles, crowd, high-voltage power lines. Please fly your air craft in the working environment as regulated in this manual. Although there are some protections, improper use may still cause permanent damage to the product.
- Always disconnect and remove batteries after use, as the ESC may drive the motor to rotate and cause unpredictable danger if it's still connected to the battery. Long-time contact will cause the battery to completely discharge and result in damage to the battery or/and the ESC. This will not be covered under warranty.

02 Features

- High performance microprocessor for excellent motor speed-governing and super soft start-up.
- Microprocessor powered by independent DC regulator has better anti-interference performance, which greatly reduces the risk of losing control.
- DEO (Driving Efficiency Optimization) Technology adopted greatly improves throttle response & driving efficiency, reduces ESC temperature.
- New switch-mode BEC with adjustable output voltage ranges from 5V to 8V and continuous/peak current of 10A/25A.
- BEC is separated from other circuits of the ESC, it will keep its normal output when the MOSFET board of the ESC is burnt.
- Multiple flight modes: Fixed-wing, Helicopter (Linear Throttle), Helicopter (EIF Governor), Helicopter (Store Governor).
- New governor program with adjustable governor parameter PII brings excellent speed-governing effect, guarantees the stability of the propeller's revs when the load changes dramatically.
- Data logging records the standardized RPM, minimum voltage and maximum temperature of the flight.
- "Restart in auto rotation" can manually interrupt the auto rotation and quickly restart the motor to avoid crashes caused by incorrect operations.
- Independent output port for RPM (that is: motor speed) signal is.
- Separate programming port for ESC programming or parameter setting.
- WiFi module (sold separately) for programming the ESC wirelessly with your smart phone (iOS or Android).
- Online data checking, ESC programming, firmware upgrade (Multifunction LCD program box or WiFi Express is needed) supported.
- Multiple protections like start-up protection, ESC thermal protection, capacitor thermal protection, over-current protection, overload protection, and throttle signal loss protection.

03 Specifications

Model	Platinum HV 130A V4	Platinum HV 130A V4 OPTO
Input Voltage	6-14S LiPo	6-14S LiPo
Cont./Peak Current	10A/25A Cont./Peak	10A/25A Cont./Peak
BEC Output	Switch-mode, 5V-8V Adjustable (Step:0.1V), 10A/25A Cont./Peak	No BEC
Separate Programming Port	For connecting Multifunction LCD Program Box / WiFi Express or fan	
Size/Weight	101x45.5x27mm / 168.5g	101x45.5x27mm / 153.5g
Applications	550-600 Class Helicopters (Propeller: 550-650mm), electric fixed-wing, multi-rotor	

04 User Guide



The default throttle range of this ESC is from 1100µs to 1940µs, you need to re-calibrate the throttle range when the first time you use this ESC or after you change the transmitter.

1 Connections

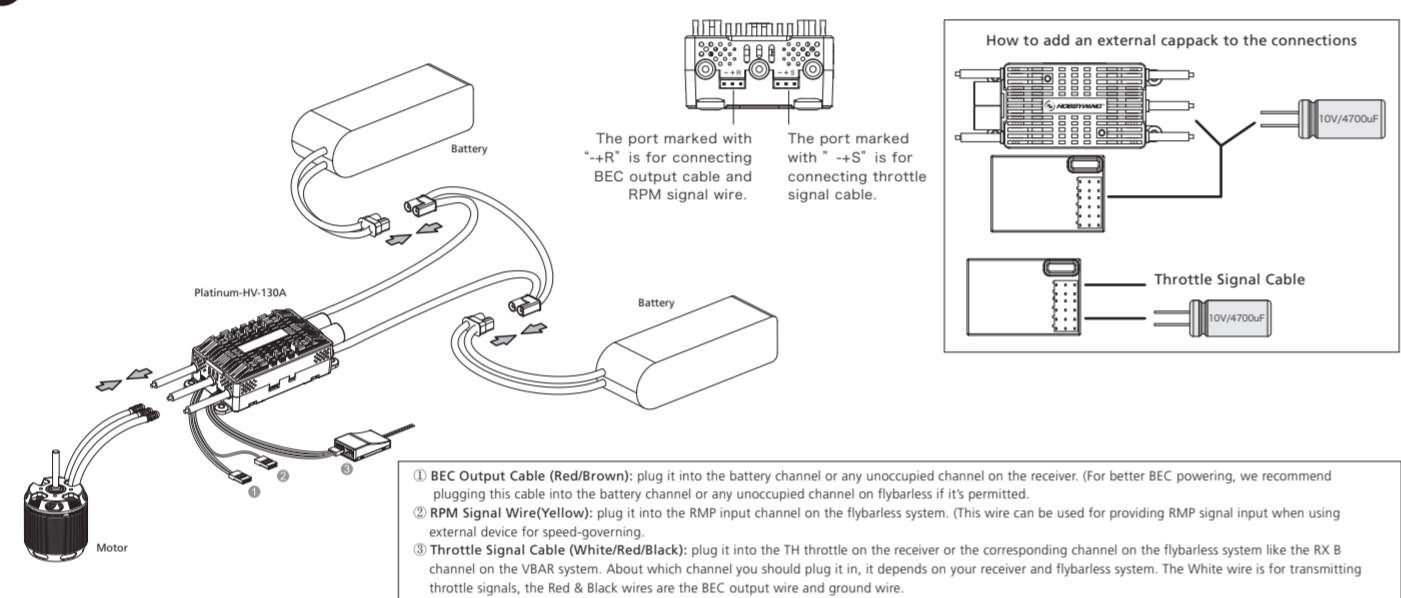

2 External Capacitor Module (also called Capped) Wiring (Optional)

For this ESC, its BEC load capacity may be insufficient when using high power servos. In that case, we suggest connecting the stock external capacitor to the BEC's output end (i.e. any idle channel on the receiver "note 1) in parallel. Users can check if the BEC is working in overload condition by the following method: keep moving relevant throttle sticks (that control servos) to start/stop those servos and change directions quickly to see if the receiver or flight control system (if exists) will be restarted during the process. If restart occurs, then it means that the sudden load of the electronic system exceeds the BEC's output capability and an external capacitor is needed.

Note 1: If there is no vacant channel on the receiver, then users can connect a short, thick Y cable (as thin, long cable may affect the capacitor's performance, so we don't recommend it) to the BEC's output wires in parallel.

3 ESC/Radio Calibration

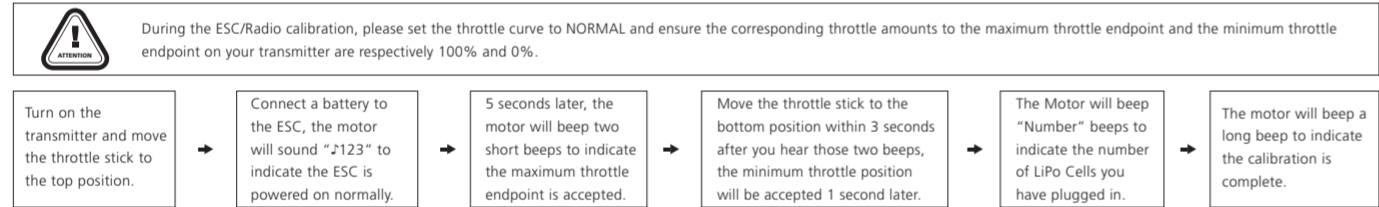

4 Normal Start-up Process

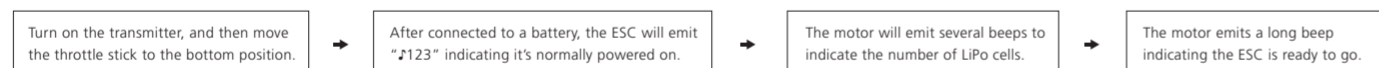

05 ESC Programming & Data Checking



- The parameters of this ESC are programmable, you can adjust relevant parameter settings to meet different flight demands.
- The ESC will record relevant data like the standardized speed (it can only be checked and won't disappear when the ESC is disconnected from the pack in "Helicopter (Store Governor)" mode), the minimum voltage, and the maximum temperature of the current flight. Therefore, if you want to check the relevant data after the flight, please keep the ESC connected to the pack and then connect the LCD program box or WiFi Express module to the ESC to check the data. Those data won't be stored after the pack is disconnected from the ESC.

1 Program Your ESC with a Multifunction LCD Program Box

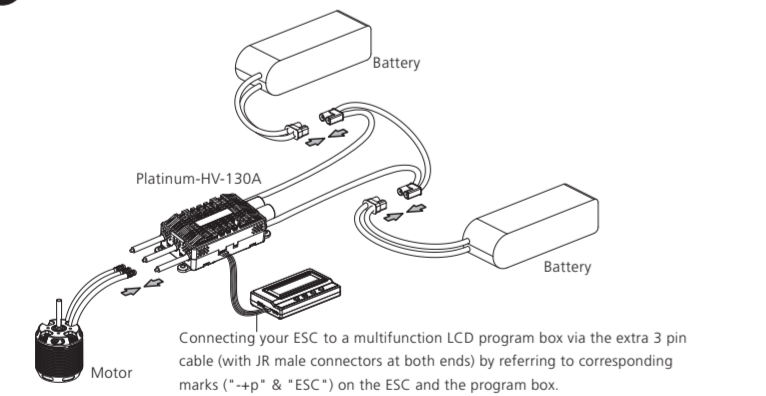

- ESC Programming**
 - Connect the LCD program box to the ESC as shown above, and then connect the battery to the ESC.
 - Press the "OK" button (on the program box) to connect the program box to your ESC, the firmware version of the ESC will be displayed on the screen of the program box after the connection succeeds.
 - After successfully entering the "Parameters/Programmable Items" page, press the "ITEM" button (on the program box) to browse the parameter(s) and then press the "VALUE" button to adjust the parameter value(s).
 - Press the "OK" button to save the new value(s) to your ESC after adjusting.
 - Repeat "step 3" and "step 4" will allow you to adjust the value(s) of other parameter(s).
 - After the programming, disconnect the ESC from the battery, unplug the cable for connecting the program box to the ESC, and then power the ESC off and then back on will allow you to run your system with those new parameter settings.

You need to power the ESC off and then back on after adjusting parameter settings, otherwise, the new values won't come into effect.

2 Check the Running Data of Your ESC

- With the battery connected to the ESC, connect the LCD program box to the ESC as shown above.
- Press the "OK" button (on the program box) to connect the program box to your ESC, the firmware version of the ESC will be displayed on the screen of the program box after the connection succeeds.
- Press the "RPM" button to enter the "Data Record" page after successfully entering the "Parameters/Programmable Items" page, continue to press the "RPM" button to browse all the running data of your ESC.
 - You can only check the standardized RPM in "Helicopter Store Governor" mode, the record won't disappear after you turn off the ESC.
 - The recorded revs are electric revs. If the electric RPM is R, the actual rev of the main blades = R ÷ Motor Poles ÷ 2 ÷ Gear Ratio × Throttle Amount (%).

2 Program Your ESC with a WiFi Express (Item sold separately)

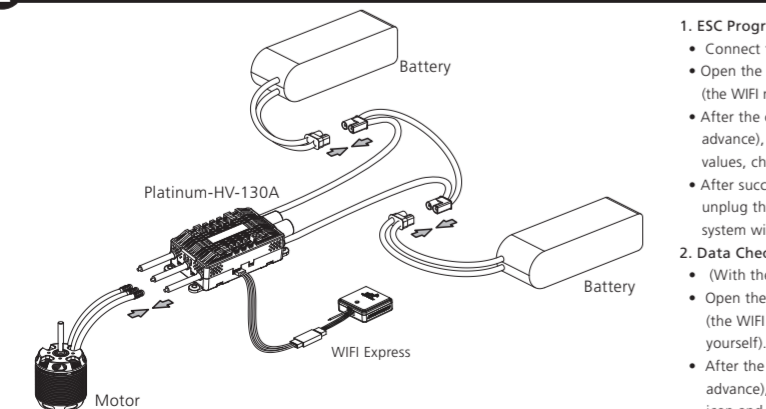

- ESC Programming**
 - Connect the ESC to the WiFi Express module as shown above, and then connect the battery to the ESC.
 - Open the WiFi setting on your smart phone and then connect (the phone to) the WiFi Express module (the WiFi name is HW-WIFILINK and the password is 12345678 by default, you can change them by yourself).
 - After the connection succeeds, open the "HW Link" APP on your phone (the APP needs to be installed in advance), click the "connect to ESC" icon (in the upper right corner), and then you can adjust parameter values, check the running data of the ESC, or carry out other operations.
 - After successfully saving the new value(s) to your ESC, disconnect the ESC from the "HW Link" APP, unplug the WiFi Express module, and then power the ESC off and then back on will allow you to run your system with those new parameter settings.
- Data Checking**
 - (With the battery connected to the ESC), connect the ESC to the WiFi Express module as shown above.
 - Open the WiFi setting on your smart phone and then connect (the phone to) the WiFi Express module (the WiFi name is HW-WIFILINK and the password is 12345678 by default, you can change them by yourself).
 - After the connection succeeds, open the "HW Link" APP on your phone (the APP needs to be installed in advance), click the "connect to ESC" icon (in the upper right corner), and then click the "Data Record" icon and "Aircraft" to check the recorded data.

3 Real-time Data Checking

- (With the battery connected to the ESC), connect the ESC to the WiFi Express module as shown above.
- Open the WiFi setting on your smart phone and then connect (the phone to) the WiFi Express module (the WiFi name is HW-WIFILINK and the password is 12345678 by default, you can change them by yourself).
- After the connection succeeds, open the "HW Link" APP on your phone (the APP needs to be installed in advance), do not click the "connect to ESC" icon (in the upper right corner) but directly click the "Data Record" icon to enter the "Data Record" Page.
- After entering the "Data Record" page, click "Aircraft" and then "Real-time Data" to enter the "Real-time Data" page, fill in the gear ratio (if it's not applicable, then fill in 1) and the pole pairs of the motor (that's to have the motor poles), and then click "OK".
- The ESC will transmit the real-time data to the "Real-time Data" page when it starts to function, you can check the data on that page.



After adjusting parameters, you need to power your ESC off and then on. Otherwise, those new parameters won't take effect.

06 Programmable Items

Programmable Item List of Platinum 60A V4 ESC. (* ** in the form below indicate factory defaults.)

Item	1	2	3	4
1 Flight Mode	Fixed-wing	Helicopter (Linear Throttle)	* Helicopter (EIF Governor)	Helicopter (Store Governor)
2 LiPo Cells	*Auto Calculation	6-14S		
3 Voltage Cutoff Type	*Soft Cutoff	Hard Cutoff		
4 Cutoff Voltage	Disabled	2.8V-3.8V (Default 3.0V)		
5 BEC Voltage	5V-8V (Default 7.4V)			
6 Start-up Time	4s-25s (Default 15s)			
7 Governor Parameter P	0-9 (Default 4)			
8 Governor Parameter I	0-9 (Default 5)			
9 Auto Restart Time	0s-90s (Default 25s)			
10 Restart Acceleration Time	1s-3s (Default 1.5s)			
11 Brake Type	*Disabled	Normal	Proportional	Reverse
12 Brake Force	0-100% (Default 0%)			
13 Timing	0°-30° (Default 15°)			
14 Motor Rotation	*CW	CCW		
15 Freewheeling	*Enabled	Disabled		
16 Start-up Force	1-7 (Default 3)			

- LiPo Cells:** The ESC will automatically calculate the number of LiPo cells you have plugged in as per the "3.7V/Cell" rule if "Auto Calc." is selected. Or user can set this item manually.
- Voltage Cutoff Type:** The ESC will gradually reduce the output to 50% of the full power in 3 seconds after the voltage cutoff protection is activated, if soft mode is selected. It will immediately cut off all the output when hard mode is selected.
- Cutoff Voltage:** 2.8V-3.8V (custom), 3.0V (default).
- BEC Voltage:** 5-8V (adjustable), 0.1V (step), 7.4V (default).
- Start-up Time:** 4-25s (adjustable), 1s (step), 15s (default). (Note: It only functions in Helicopter (Store Governor) and Helicopter (EIF Governor))
- Governor Parameter P:** Control the ESC maintaining the stability of the current motor speed.
- Governor Parameter I:** Control the dynamic response. To be specific, control the supplement extent when the actual motor speed is below expectation. If you choose a very big value, then the supplement may be too much. If select a very small value, then the supplement may not sufficient.
- Auto Restart Time:** The ESC will cut off its output when the throttle amount is between 25% and 40%. If you increase the throttle amount to above 40% within preset time period (0-90s), the motor will rapidly start up and accelerate to the speed (in the programmed Restart Acceleration Time) corresponds to the specific throttle amount, complete the shutdown and restart up. If you move the throttle stick to over 40% beyond the preset time period, the ESC will enter the soft start-up process. (Note: This function won't effect unless the throttle amount is over 25% and it only effects in "Helicopter (Store Governor) and Helicopter (EIF Governor)" mode.)
- Restart Acceleration Time:** 1-3s (adjustable), 0.5s (step), 1.5s (default). This item controls the time the motor will cost to restart and accelerate to the full speed. (This function only effects in "Helicopter Governor EIF/Store" mode)
- Brake Type:**
 - Proportional Brake: when the throttle range on the transmitter is between 20% and 100%, the corresponding ESC throttle output is between 0% and 100%. When the throttle range on the transmitter is between 20% and 0%, the corresponding brake force is between 0 and 100%.
 - Reverse: after selecting this option, the RPM signal wire will turn into a reverse signal wire (the signal range is in line with the throttle range). After setting a channel on the transmitter, when the reverse signal length is above 50% signal length, the Reverse mode will be activated. The reverse signal length must be below 50% signal length when the ESC is powered on for the first time. When the reverse signal length is below 50% signal length, 0-100% throttle corresponds to "CW"; when the reverse signal length is above 50% signal length, the motor will stop spinning CW (and then spin CCW); at this time, 0-100% throttle corresponds to "CCW". Any signal loss will activate the throttle signal loss protection, no matter it happens to the RPM signal wire or the throttle signal cable during the flight.
- Brake Force:** 0-100% (adjustable), 1% (step), 0 (default). (Note: this function only effects in "Normal Brake" mode.)
- Timing:** 0-30° (adjustable), 1° (step), 15° (default).
- Motor Rotation:** CW/CCW. User can adjust this item via a multifunction LCD program box.
- DEO (Freewheel):** User can decide this function "Enabled" or "Disabled" in "Fixed Wing" mode or in "Helicopter (Linear Throttle)" mode. This item has been preset to "Enabled" and cannot be adjusted in "Helicopter (Store Governor) and Helicopter (EIF Governor)" mode. This function can bring better throttle linearity.
- Start-up Force:** This item is for adjusting the start-up force of the motor (during the start-up process). The higher the value, the larger the start-up force. It's adjustable between 1 and 7 (and it's 3 by default).

07 Speed-governing Function



- The best throttle amount (set in the Helicopter "Store Governor" mode) of the ESC ranges from 70% to 90%, so please try to set the throttle amount (set in the Helicopter "Store Governor" mode) within this range. A low throttle amount (set in the Helicopter "Store Governor" mode) will make the ESC always function inefficiently, while a high throttle amount (set in the Helicopter "Store Governor" mode) will leave the ESC a very small compensation space, then compensation insufficiency issue may happen and cause (speed decrease) problem when the load is high. In that case, we recommend changing the motor or drive gear ratio (you need to re-standardize the speed after you change the motor or drive gear ratio).
- In the "Helicopter (Store Governor)" mode, if you fly your aircraft with a low performance battery after standardizing the speed with a high performance battery you may cause damage to the low performance battery.
- In "Helicopter (Store Governor)" mode, different battery packs can bring the same stable RPM only if they have the same cell count. This won't change even when you change the battery pack. However, battery packs with different cell count don't have the same effect. For instance, in "Helicopter (Store Governor)" mode, you can't use a 4S to calibrate the motor RPM and then use a 6S to drive the motor, hoping it can run at the same RPM.
- You can decide the control feel via adjusting Governor Parameter PII. In "Helicopter (Store Governor) or Helicopter (EIF Governor)" mode, connect your ESC to a smart phone or PC, then you can check the "throttle vs speed" chart.

1 Explanation for ESC Speed-governing

Establish the "Motor RPM-Throttle Amount Curve" via the speed standardization, and then set the throttle amount to some fixed value on the transmitter, in that condition, the motor will output the RPM corresponds to the throttle amount and keep rotating at that speed.

- In the "Helicopter (EIF Governor)" mode, the ESC won't save the "Motor RPM-Throttle" curve after it's disconnected from the battery, so every time the ESC is connected to the battery, it will standardize the speed, otherwise you cannot use the speed-governing function normally. In this mode, due to the differences like batteries' different discharge capacity, the standardized RPM is a little different every time. In consequence, at the same throttle amount, the RPM may be a bit different when using different batteries, but this won't affect the speed-governing effect.
- In the "Helicopter (Store Governor)" mode, the ESC will save the "Motor RPM-Throttle" curve after the speed standardization. So after adjusting to this mode from any other mode, you need to standardize the speed when the ESC is connected to the battery for the first time and you needn't standardize the speed again after disconnecting the ESC from the battery first and then connecting it to the battery again. If adjusting to any other mode from this mode and saving the "Motor RPM-Throttle" curve, and then adjusting back to this mode, the "Motor RPM-Throttle" curve saved by the ESC will be cleared, and you need to standardize the speed once again. If your ESC remains in this mode in future, then it will always carry out its operation as per the saved "Motor RPM-Throttle" curve. When standardizing the speed for the first time, we recommend using a battery in good condition. After the RPM standardization, change another battery with the same number of cells to fly your aircraft. At the same throttle amount, the RPM should be consistent with the RPM of the first flight.

2 RPM Standardization

- Theory of RPM Standardization**

During the RPM standardization, the ESC will establish a "Motor RPM-Throttle" curve by itself based on the actual battery voltage and the actual KV rating of the motor. Therefore, you need to standardize the speed with a fully charged battery, and ensure the main blade pitch is 0° (in order to make the helicopter not take off). In general, people use the default "Throttle Curve & Pitch Curve" of the transmitter (as shown below) when they standardize the speed.

Attention! Please ensure the main blade pitch is 0° and the throttle amount is above 40% (we recommend using 50%) when standardizing the speed.
- Procedures of RPM Standardization**
 - We recommend using the default "Throttle Curve & Pitch Curve". If you don't want to use the default setting, then please ensure the throttle amount is 50% and the main blade pitch is 0° when the motor rotates.
 - Turn on the transmitter, move the throttle stick to the bottom position and then wait for the ESC completing the self detection.
 - If you've set the "throttle cut" function, please lock the "throttle cut", and then move the throttle stick to the 50% position and then unlock the "throttle cut". If there is no "throttle cut", then you can move the throttle stick to the 50% position directly.
 - The ESC drives the motor to rotate, the main blades start to accelerate slowly (because the main blade pitch is 0°, so the helicopter won't take off, but you still need to be careful), you need to wait for the acceleration completing and the speed getting stable, and then lock the "throttle cut" or move the throttle stick to the bottom position.
 - The ESC will stop driving the motor, the main blades start to slow down and then stop rotating.
 - The RPM standardization completes.

Attention! Please calibrate the throttle range before the RPM standardization. There will be no need if you've carried out the ESC/Radio Calibration when the first time you used this ESC or you didn't restore the settings to factory defaults after the calibration (changing the transmitter & receiver is an exception).

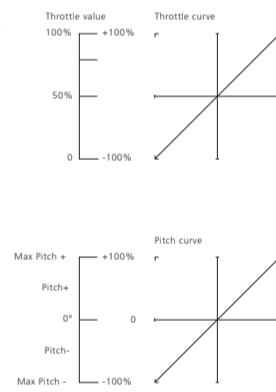

3 How to Set the Speed-governing Function

- In "Helicopter (Store Governor)" mode, you can check the standardized speed (Max. RPM) and needn't standardize the speed every time when the ESC is connected to the battery as in the "Helicopter (EIF Governor)" mode, so it's more convenient. We recommend using this mode in the condition that you're using fixed motor, drive gear ratio and battery (with same cell count). In this mode, only if the drive gear ratio is accurate, the main blades' RPM corresponds to the throttle amount (set in the Helicopter "Store Governor" mode) you will get will be accurate as well. About how to "set the speed-governing function" in this mode, let's take an example.
 - In "Helicopter (Store Governor)" mode, connect the ESC to the LCD program box or WiFi Express module when the RPM standardization completes, and then find the record (as shown in Figure 1) as per the instruction about the "data checking" process.
 - The value shown in the image is just an example, please take the value actually displayed on your LCD program box as standard. This value is the max. electrical RPM the motor can reach at the 100% throttle.
 - Take a helicopter with single reduction gear unit as an example, with the motor poles is 10, the motor drive gear is 13T and the main drive gear is 120T (that the drive gear ratio is 9.3), then you can get the main blades' RPM at the 100% throttle.

Formula: Main Blades' RPM (at the 100% throttle) = Max. RPMs (Motor Poles ÷ 2) ÷ Drive Gear Ratio

The Main Blades' RPM (at the 100% throttle) in the example is: 157 × 1000 ÷ (10 ÷ 2) ÷ (120 ÷ 13) = 3400 RPM. If the Main Blades' RPM needs to remain at 2700RPM during the 3D flight process, then you need to set the throttle amount (set in the Helicopter "Store Governor" mode) to 2700 ÷ 3400 × 0.8, that is you need to set the throttle amount to 80%. At this time, you need to set the value of the 3D throttle curve (i.e. IDLE1) to 80% (as shown in Figure 2). So next time, when you fly your helicopter, let it take off in the "Normal" mode first and then switch to the "IDLE1" mode directly, then your helicopter can starts the 3D flight with 80% throttle amount (that's the standardized speed of 2700 RPM).

Notes: in general, you can set and save 2/3 sets of throttle curve IDLE settings on a high quality transmitter (and you need to adjust the main blade pitch of each set of IDLE setting as per the actual demand), and switch between these settings during the flight and have the different throttle amount (set in the Helicopter "Store Governor" mode) to meet the different RPM demands (i.e. when setting IDLE1 to 70%, IDLE2 to 80%, IDLE3 to 90% in the way as explained earlier, then you will have three different throttle amounts (set in the Helicopter "Store Governor" mode) to meet different flight demands).
- In the "Helicopter (EIF Governor)" mode, you are not allowed to check the Max. RPM, so you need to set the transmitter in advance and check the main blades' RPM with the help of some external device (like RPM viewer) and then decide the throttle amount you need to set. Here you can calculate the throttle amount roughly. For example, if the KV rating of the motor is 480KV, the battery is 12S LiPo, the motor drive gear is 13T and the main drive gear is 110T, then the main blades' RPM is: KV Rating × Battery Voltage ÷ Drive Gear Ratio (480 × 12 × 4 ÷ 2 ÷ 13 × 110 = 2850). So if you want your motor to rotate at the speed of 2150RPM, then the throttle amount is: 2150 ÷ 2850 × 0.75 (that is 75%), and then you adjust it accordingly as per your preference or the data you read on the RPM viewer.

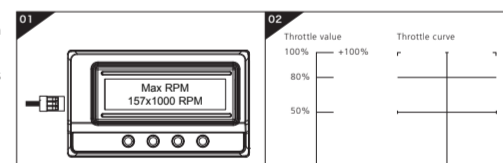

08 Warning Tones & Protections

Trouble	Warning Tone	LED Status	Cause
The input voltage is abnormal.	"BB , BB , BB , ..."	(Along with the beeps), the Red LED flashes.	The input voltage is not within the regulated range.
The throttle signal is lost.	"B , . , B , . , B , ..."	(Along with the beeps), the Red LED flashes.	The ESC doesn't detect any throttle signal input.
The throttle stick is not moved to the bottom position.	"B , B , B , ..."	(Along with the beeps), the Red LED flashes.	The ESC detects that the throttle is above 0%.
The throttle range is too narrow.	"B , B , B , ..."	(Along with the beeps), the Red LED flashes.	You set the throttle range too narrow during the ESC/Radio Calibration.
The ESC thermal protection is activated.	No	The Blue LED flashes a short, single flash or three times flash that repeats.	The internal temperature of the ESC goes above the regulated temperature range.
The low-voltage cutoff protection is activated.	No	The Blue LED flashes a short, double flash that repeats.	The operating voltage goes below the preset cutoff voltage.
The over-current protection is activated.	No	The Red LED flashes on solid.	The operating current goes above the regulated value.

During the normal operation, the Blue LED on the ESC will turn solid after the start-up completes. The Red LED will come on at full throttle and dies out at partial throttle.

- Protections**
 - Throttle stick is not at the bottom position:** The motor will beep "B-B-B-B-B" when the throttle stick is not moved to the bottom position.
 - Throttle range is too narrow:** The motor will beep "B-B-B-B-B" when the throttle range you set is too narrow (when designing this ESC, it requires that the entire throttle range you set cannot be less than 50% of the whole throttle range available on the transmitter). The warning tone indicates the throttle range you set is void and you need to set it again.
 - Power-on Abnormal Voltage Protection** The ESC will measure the input voltage when it's connected to a battery or power supply. If the input voltage is not within the regulated range, it will take the voltage as an abnormal voltage and then activate the protection, flash Red LED and beep a series of beeps.
 - Start-up Protection:** The ESC will monitor the motor speed (RPM) during the start-up process. When the speed stops increasing or the speed increase is not stable, the ESC will take it as a start-up failure. At that time, if the throttle amount is less than 15%, then the ESC will automatically try to restart up; if it is larger than 15%, then you need to move the throttle stick back to the bottom position and then restart up the ESC. (Possible causes of this problem: poor connection/disconnection between the ESC and motor wires, propellers are blocked, etc.)
 - ESC Thermal Protection:** The ESC will gradually reduce the output but won't cut it off completely when the ESC temperature goes above 110°. For ensuring the motor can still get some power and won't cause crashes, so the maximum reduction is about 50% of the full power. The ESC will gradually resume its maximum power after the temperature lowers down. In addition, the ESC temperature cannot exceed 70° when it's powered on. Otherwise, it cannot be started up but flashes Blue LED and beeps a series of beeps to indicate the ESC temperature is too high. (Here we are describing the ESC's reaction in the "Soft Cutoff" mode, while if in the "Hard Cutoff" mode, it will immediately cut off the power.)
 - Throttle Signal Loss Protection:** When the ESC detects loss of signal for over 0.25 second, it will cut off the output immediately to avoid an even greater loss which may be caused by the continuous high-speed rotation of propeller. The ESC will resume the corresponding output after normal signals is received.
 - Overload Protection:** The ESC will cut off the power/output and automatically restart itself when the load suddenly increases to a very high value. If the load still remains high or the motor still remains out of sync, then it will completely cut off the power/output.
 - Low-voltage Cutoff Protection** When the operating voltage goes below the preset cutoff voltage, the ESC will gradually reduce the output but won't cut it off completely. For ensuring the motor can still get sufficient power to land the aircraft safely, so the maximum reduction is about 50% of the full power. You need to change another fully charged battery to resume the operation when the low-voltage cutoff protection is activated.
 - Over-current Protection** During use, the ESC will cut off the output immediately if the current exceeds the regulated value and then resume it quickly; the ESC will cut off the output completely and won't resume it if the regulated value is exceeded again.